

Parton saturation and hydrodynamical evolution in pPb collisions (EPOS3)

Klaus Werner <werner@subatech.in2p3.fr>

in collaboration with

B. Guiot, Iu. Karpenko, T. Pierog

Key elements of EPOS3 (model for pp, pA, AA)

E nergy conserving multiple scattering

P arton ladders (multiple)

O ff-shell (excited) remnants

S aturation (NEW)

3 dim viscous EbyE hydro (NEW)

+ hadronic afterburner

Energy conserving multiple scattering

Saturation

E nergy conserving multiple scattering



closely related
both necessary
for a consistent MS scheme

S aturation

E nergy conserving multiple scattering



closely related
both necessary
for a consistent MS scheme

S aturation

3 dim viscous EbyE hydro (first results)

“Historical” result, showing need of better understanding of multiple scattering

pp@1800GeV
data: CDF

Phys.Rev.D
Vol 65,
072005 (2002)

many more
“multiple scattering”
sensitive observables
measured at the LHC

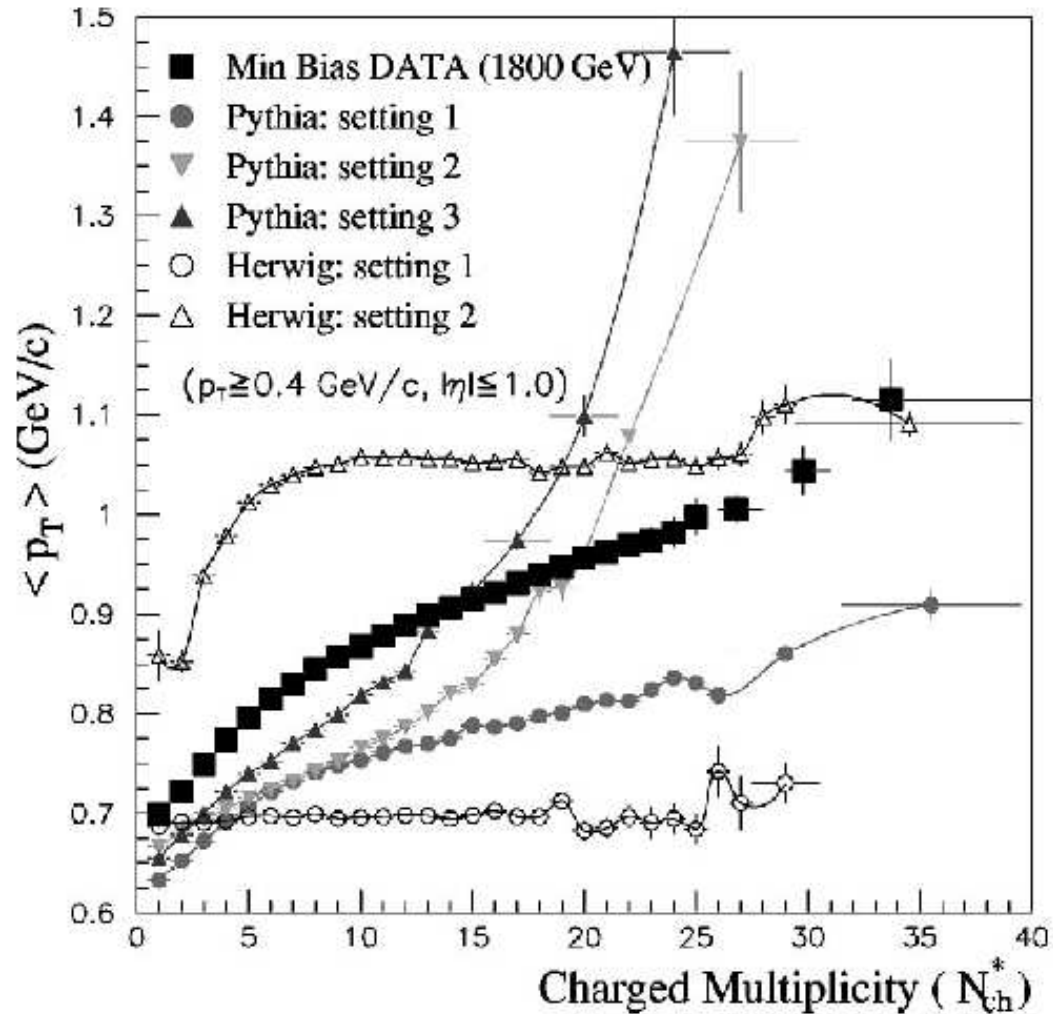

J/Psi yield versus charged multiplicity

(ALICE, CERN-PH-EP-2012-021)

ALICE

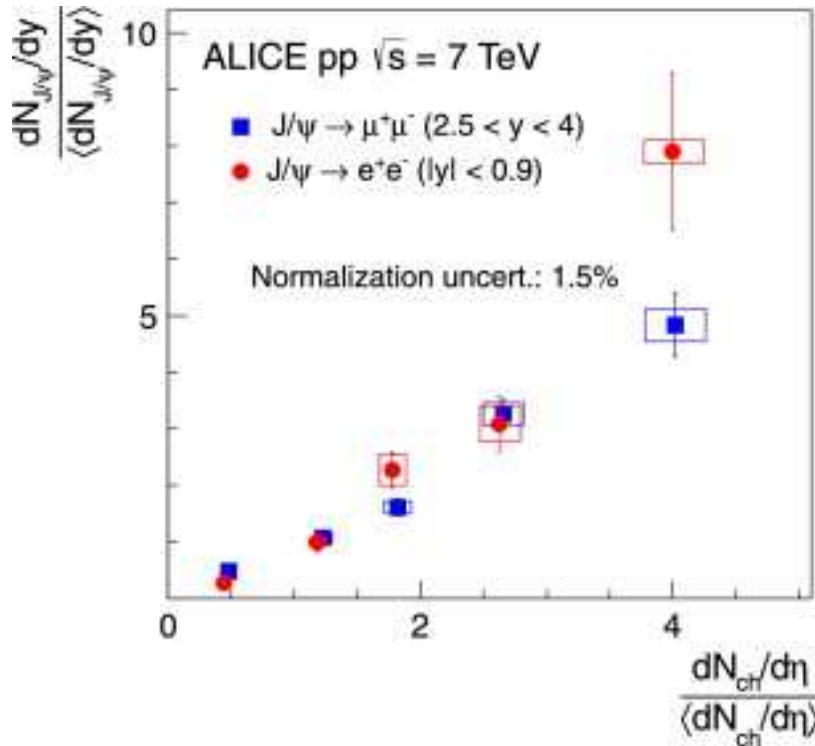

Pythia

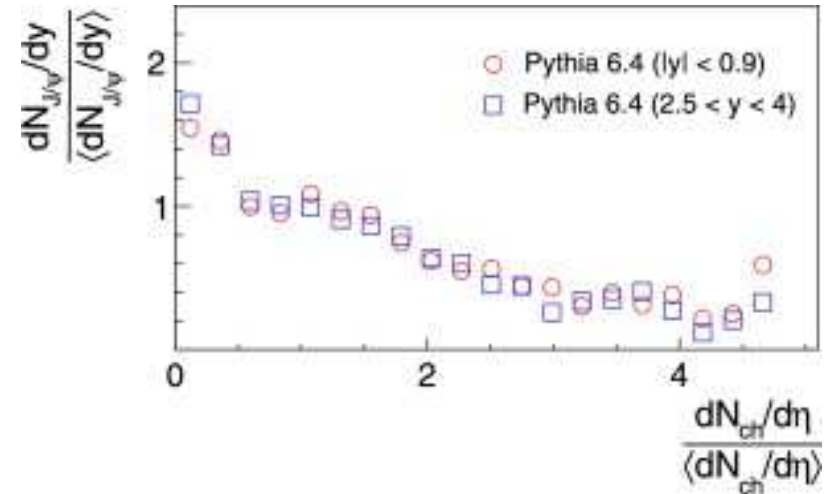

Recent LHC pp publications
(mainly ATLAS, CMS, LHCf)
usually compare with

- Pythia tunes

- three “Cosmic ray models”
including EPOS

EPOS works quite well, partly thanks to
multiple scattering

**What makes EPOS very different
compared to models like Pythia?**

Two fundamentally different approaches

(1) Starting from the factorization formula,

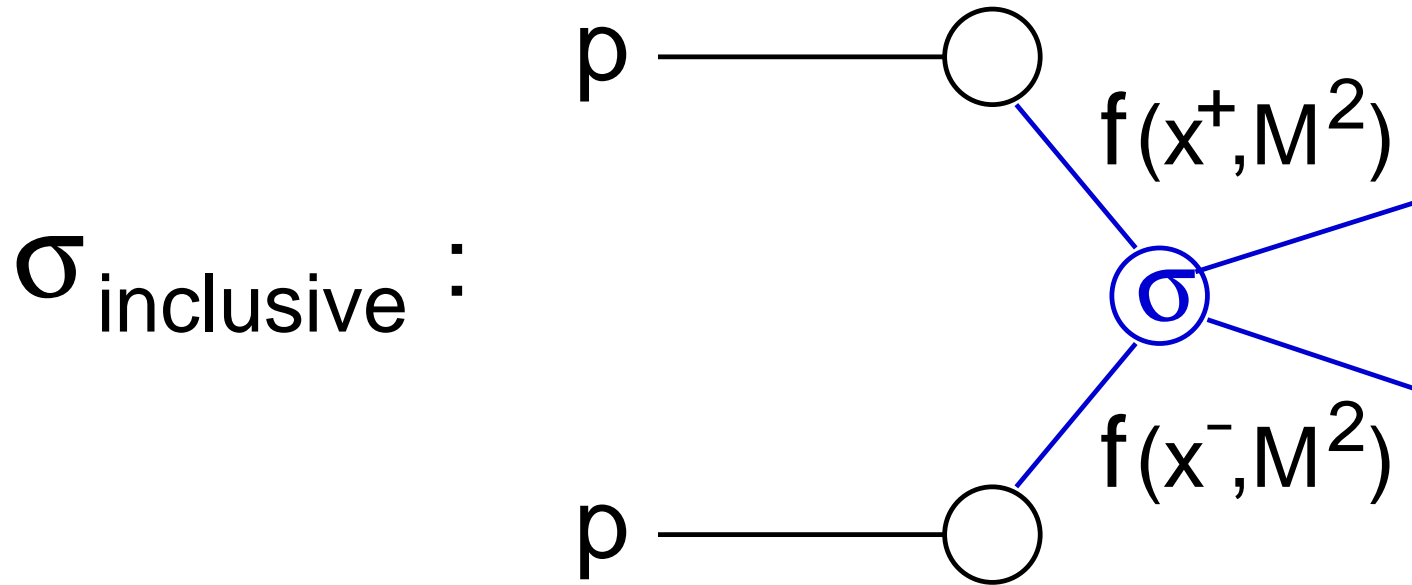

one “reconstructs” multiple scattering such that factorization is reproduced;

PDFs f are input

(2) Starting from a Gribov-Regge multiple scattering Ansatz, one ends up
(if things are done properly) with

factorization for $\sigma_{\text{inclusive}}$ (pp, AA)

binary scaling (AA, also pp)

PDFs are outcome,
also σ_{tot} , σ_{el} and much more

Some history of GRT:

- 1960-1970: Gribov-Regge Theory of multiple scattering.
pp = multiple exchange of “Pomerons”
(parametrized amplitudes)
- 1980-1990: pQCD processes added into GRT scheme (Capella)
- 1990: M.Braun, V.A.Abramovskii, G.G.Leptoukh:
problem with energy conservation
(not done consistently)

- 2001: H.J.Drescher, M.Hladik, S.Ostapchenko, T. Pierog, and K. Werner, Phys. Rept. 350, p93: Marriage pQCD + GRT, **with energy sharing**

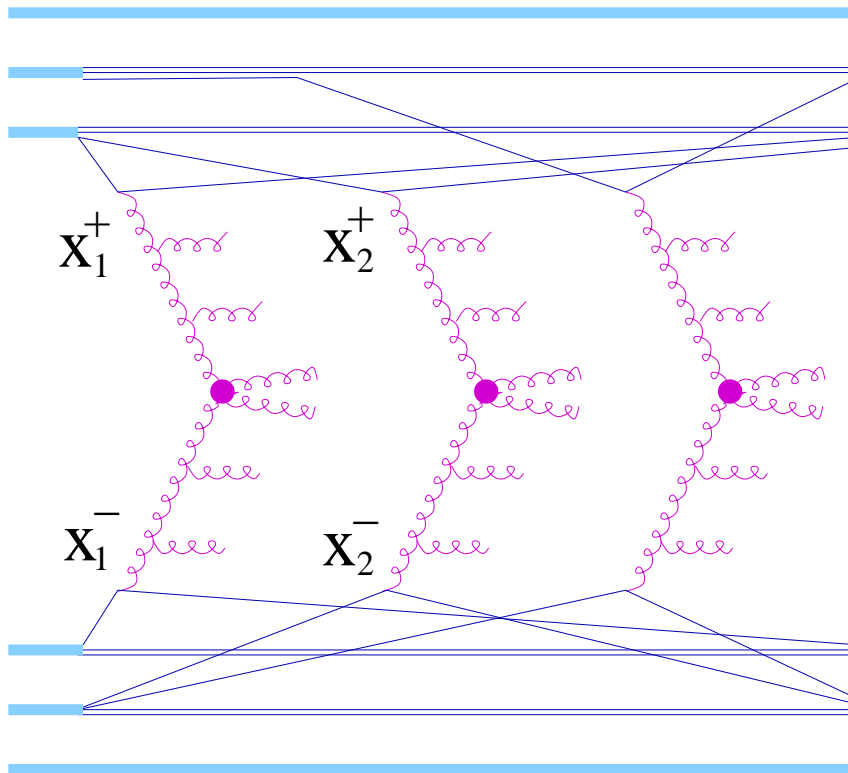

Multiple scatterings
(in parallel !!)
in pp, pA, or AA

Single scattering

= hard elementary
scattering
including
IS + FS
radiation

$$\sum x_i^\pm + x_{\text{remn}}^\pm = 1$$

- 2001: H.J.Drescher, M.Hladik, S.Ostapchenko, T. Pierog, and K. Werner, Phys. Rept. 350, p93: Marriage pQCD + GRT, **with energy sharing**

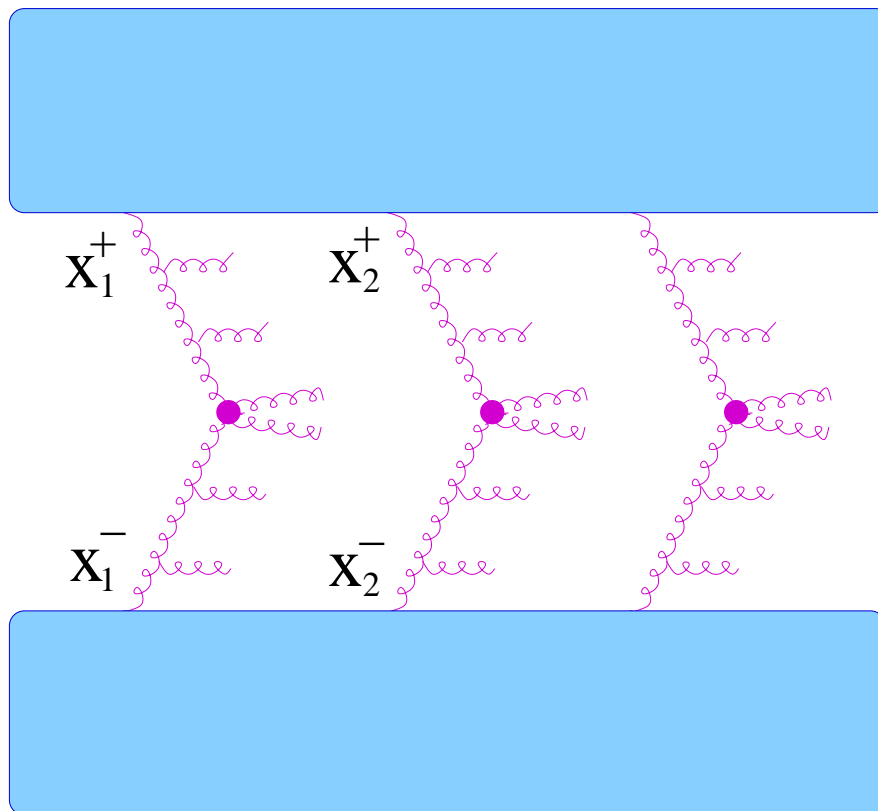

Multiple scatterings
(in parallel !!)
in pp, pA, or AA

Single scattering

= hard elementary
scattering
including
IS + FS
radiation

$$\sum x_i^\pm + x_{\text{remn}}^\pm = 1$$

Nice : pA and AA is a straightforward generalization of pp (at least concerning the initial stage)

one cannot separate pp, pA, AA (initial)

Picture is not yet complete (Clear from the beginning)
in particular visible in pA,AA

□ Introducing energy conservation (which is a must)

□ one generates a violation of “binary scaling”,

$$R_{AA} = \left(\frac{1}{N_{\text{coll}}} \frac{dn}{dp_t} \Big|_{AA} \right) / \left(\frac{dn}{dp_t} \Big|_{pp} \right) = 1$$

in pA (and AA for photons) at high p_t ,
whereas data show scaling

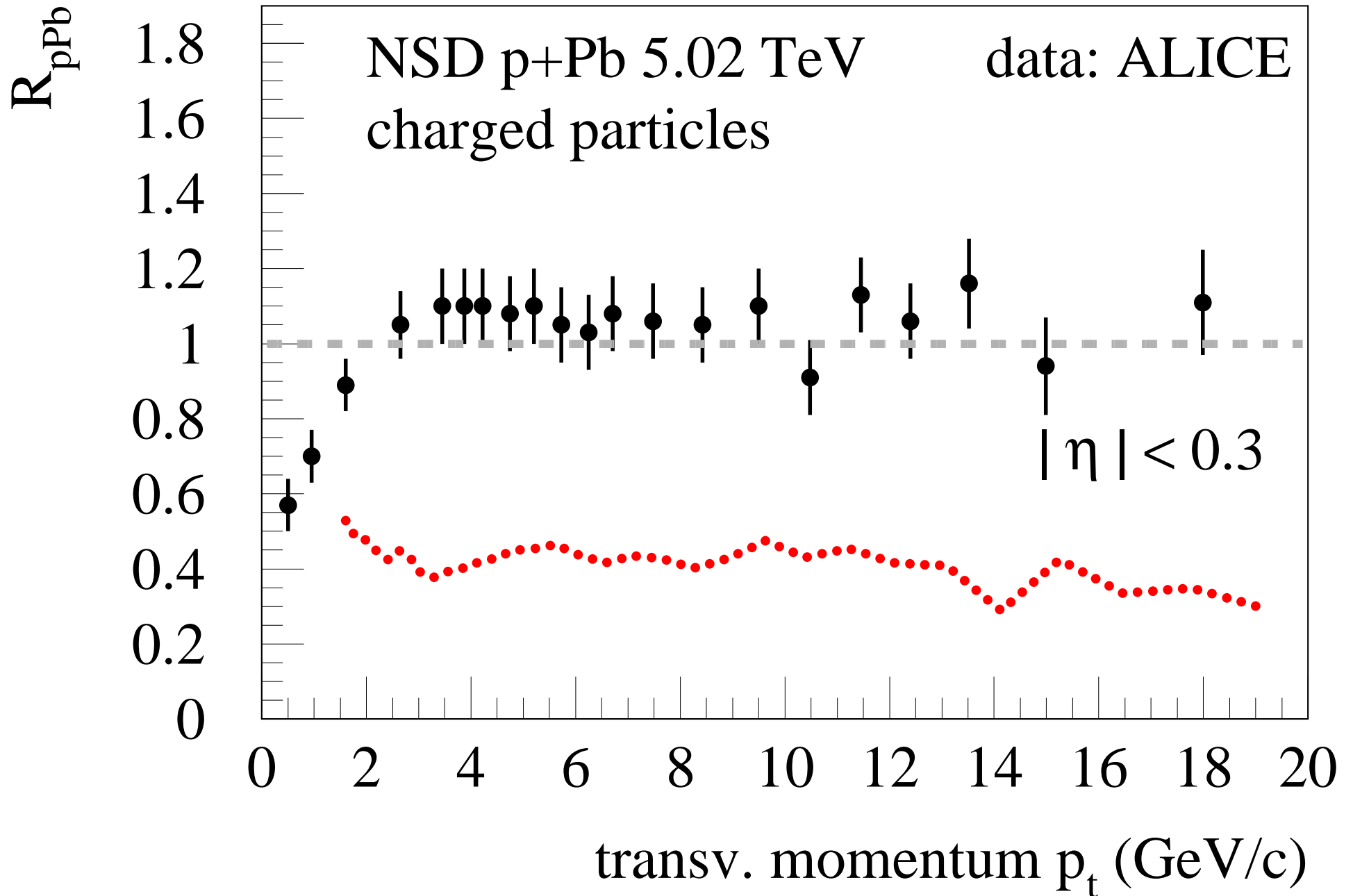

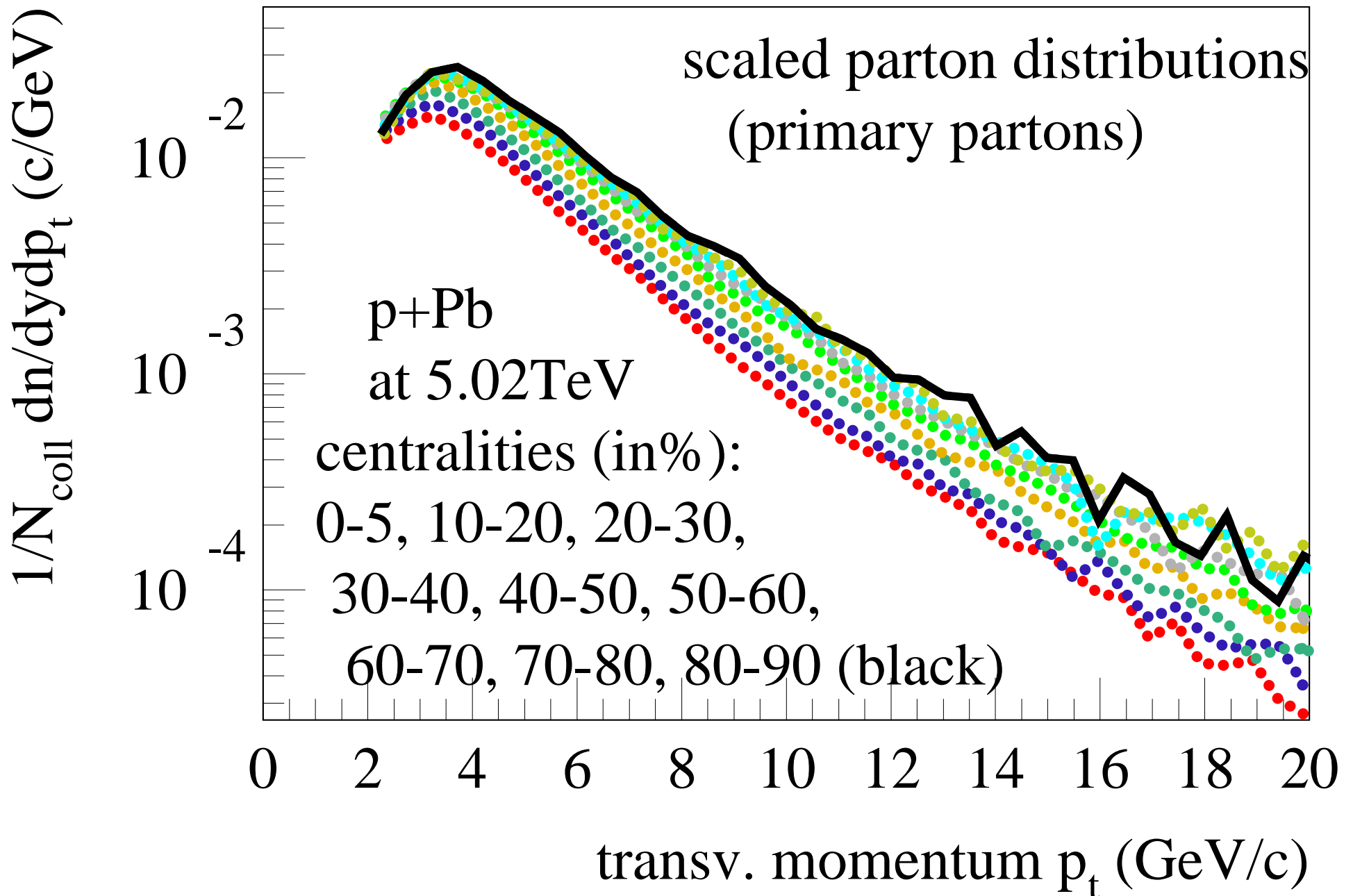

Missing:

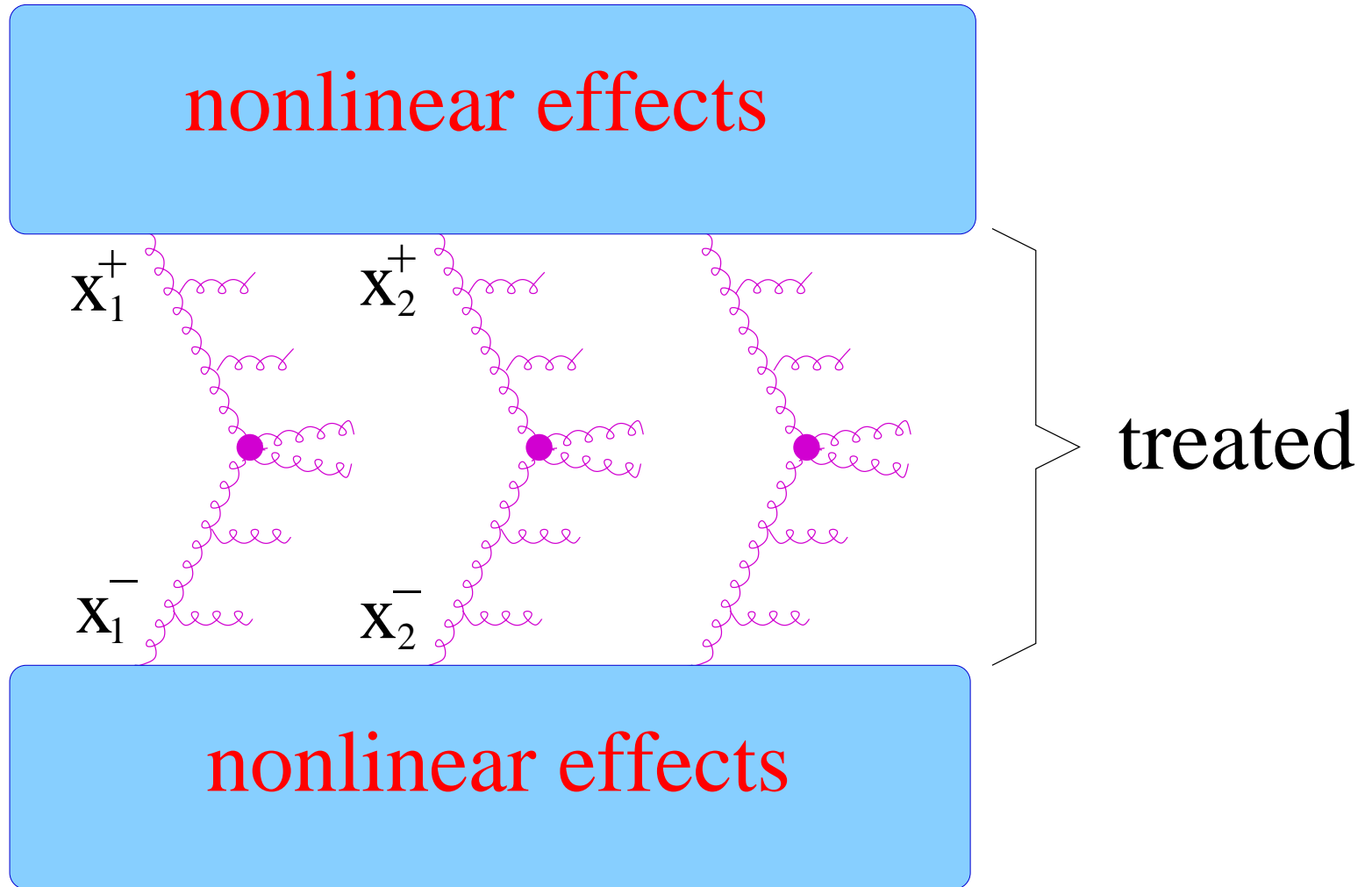

**Already needed in pp : total cross section,
 $dn/dy(0)$ explode at high energy**

First attempts to include “nonlinear effects” in a simple way, could not solve the “binary scaling problem”

New solution

based on the saturation scale Q_s

L. McLerran, R. Venugopalan, Yu. Kovchegov,
J. Jalilian-Marian, A. Kovner, A. Leonidov, H. Weigert,
E. Iancu, D. Kharzeev, E. Levin, M. Nardi, ...

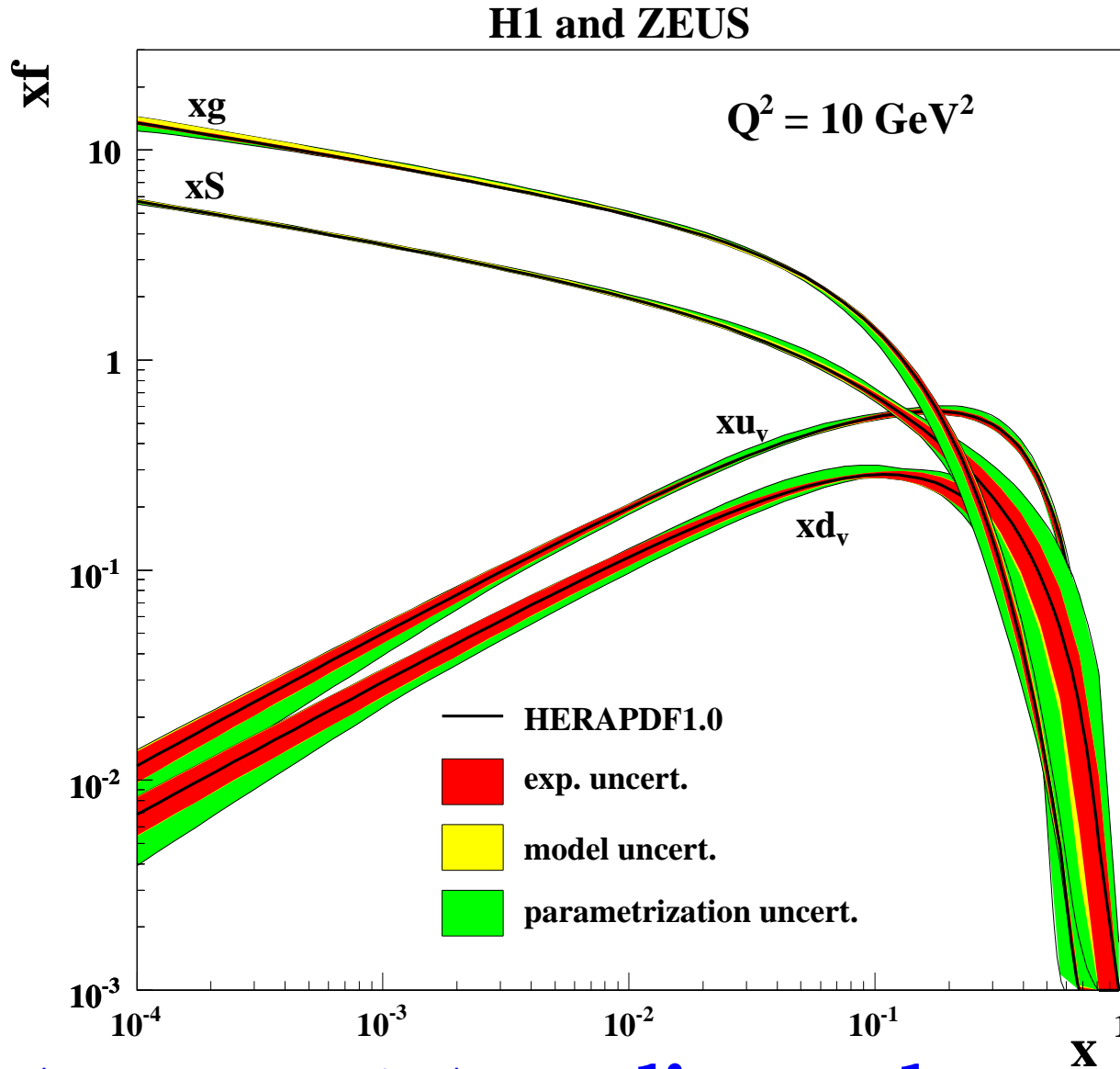

Known
from HERA:

Gluon density
grows strongly
at small x ,

cannot continue forever...

at some point **nonlinear dynamics** must take over
(which limits the growth)

Nonlinear dynamics
leads to **saturation**

characterized by the
saturation scale Q_s^2

(below which
non-linear dynamics
dominates)

Geometrical
picture

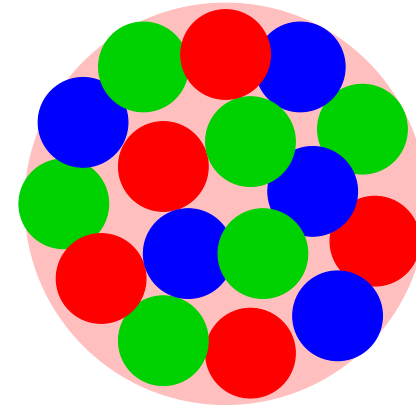

the gluons fill com-
pletely the trans-
verse area of the
proton (nucleus)

Q_s^2 depends on x and nuclear properties.

Popular expressions:

$$Q_s^2 \sim \frac{A^{1/3}}{x^\lambda},$$

or (for the centrality dependence)

$$Q_s^2 \sim \frac{N_{\text{part}}}{x^\lambda},$$

with $\lambda \approx 0.3$, N_{part} : nr of participating nucleons.

Easy to implement in factorization models,

not so obvious in a multiple scattering scheme.

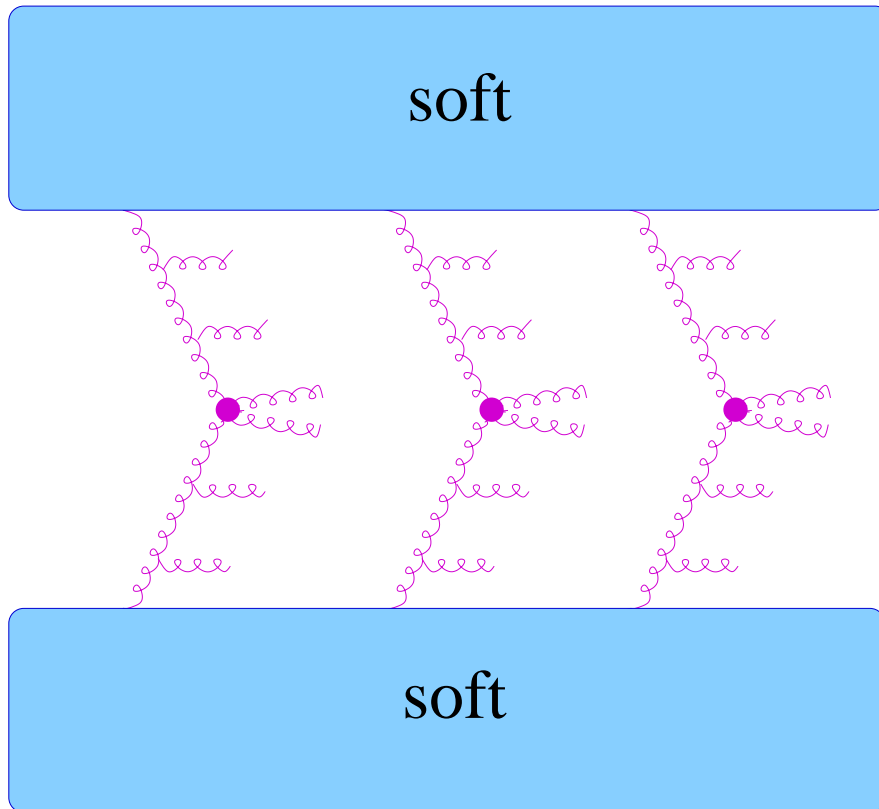

In EPOS, so far

we use a soft scale
 $Q_0^2 = 4 \text{ GeV}^2$ to separate soft from pQCD

Should be replaced
by Q_s^2 which may
varie from ladder to
ladder

New procedure: Implementing $\mathcal{Q}_s \sim \mathbf{N}_{\text{part}}$

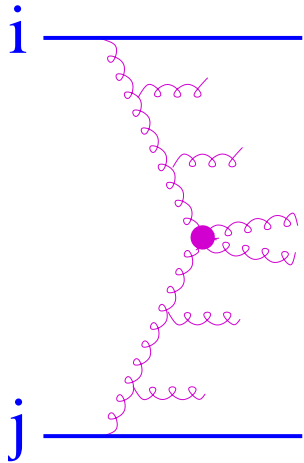

For a parton ladder connected to projectile nucleon i and target nucleon j , one defines the “participant number”

$$N_{\text{part}}(i, j) = \max \left\{ N_{\text{part}}^{\text{targ}}(i), N_{\text{part}}^{\text{proj}}(j) \right\}$$

with

$N_{\text{part}}^{\text{proj}}(j)$:= number of proj nucleons “interacting” with j

$N_{\text{part}}^{\text{targ}}(i)$:= number of target nucleons “interacting” with i

(For a given Monte Carlo configuration)

The usual soft scale

$$Q_0^2 = 4\text{GeV}^2$$

is replaced by ($\sqrt{s_{\text{ladd}}} = \text{cms energy of the ladder}$)

$$Q_s^2 \propto N_{\text{part}}(i, j) \times s_{\text{ladd}}(i, j)^\lambda$$

$$Q_s^2 = \max\left(Q_0^2, Q_s^2\right)$$

So each parton ladder has “its own” saturation scale, depending on the number of connected participants and its cms energy

Relation between string “length” and saturation scale:

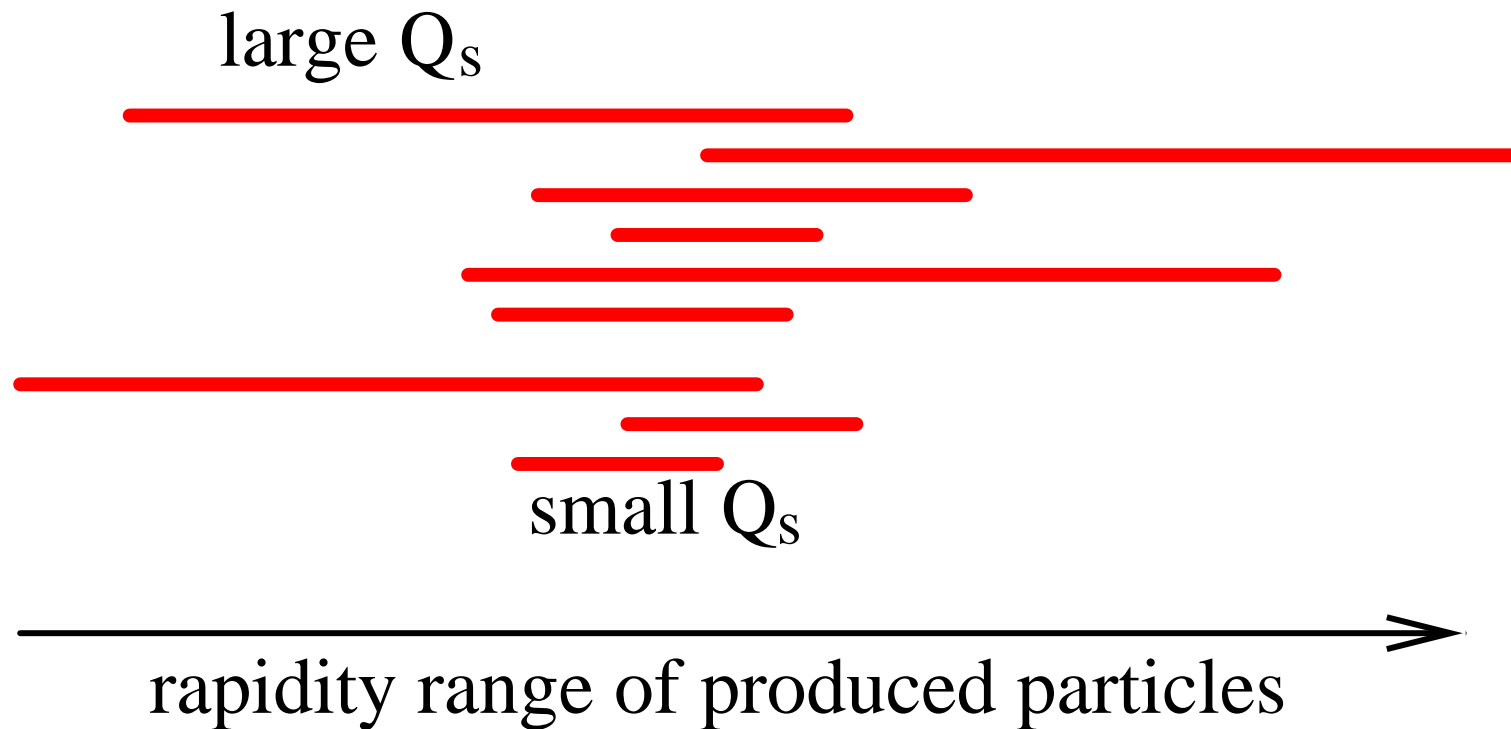

Results

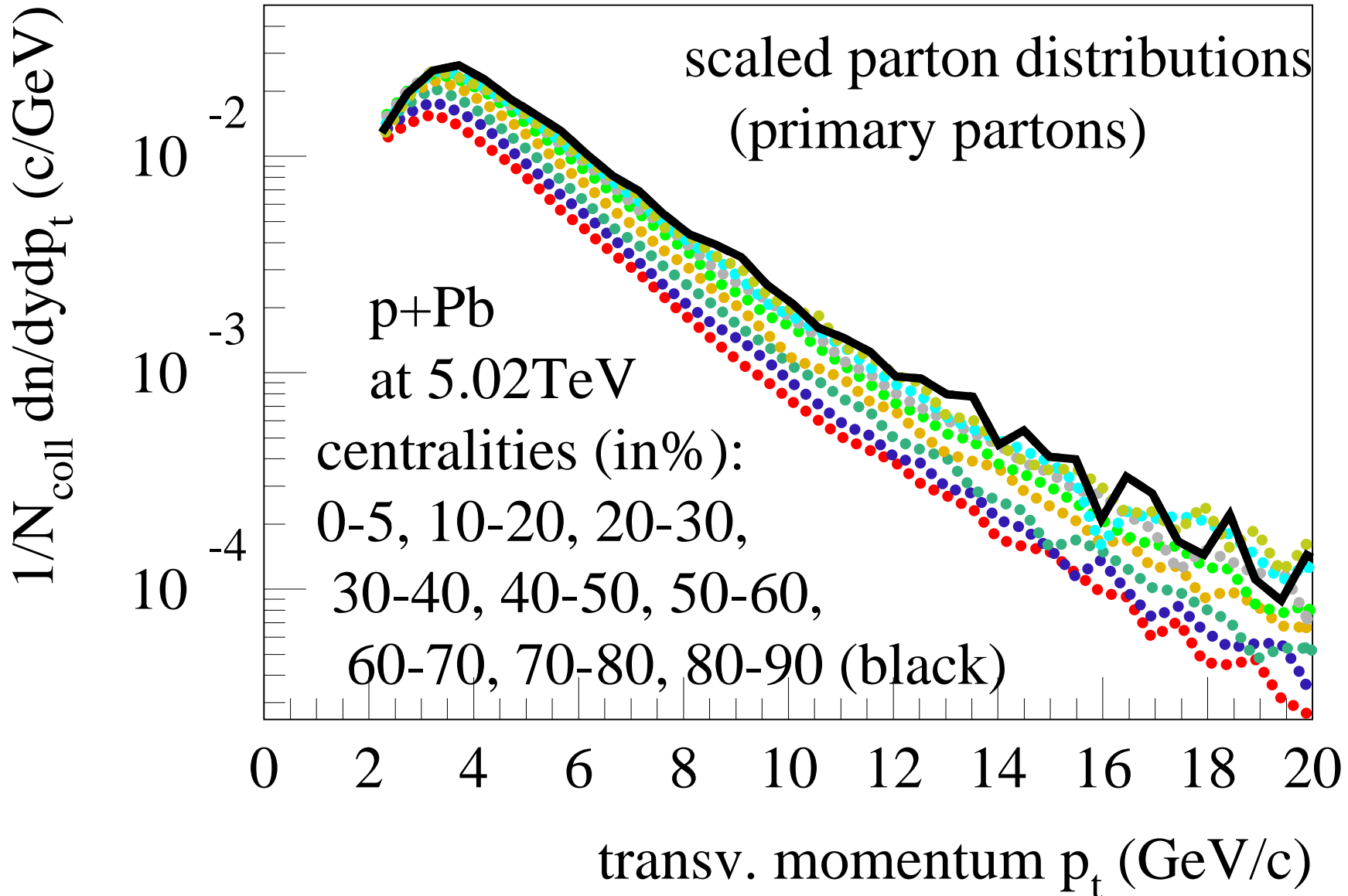
pPb with constant scale Q_0 

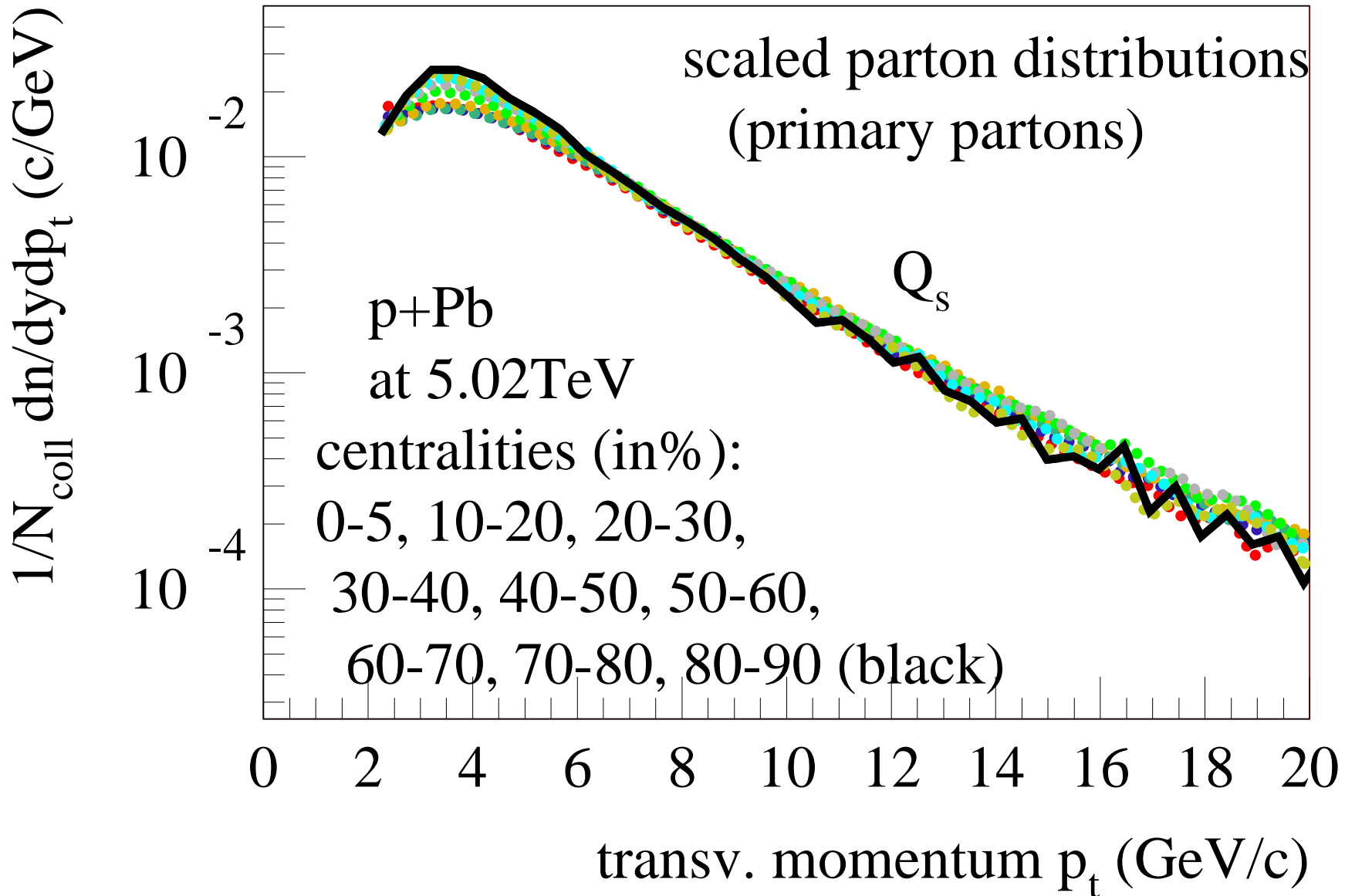
... with saturation scale

Charged particle production in pPb

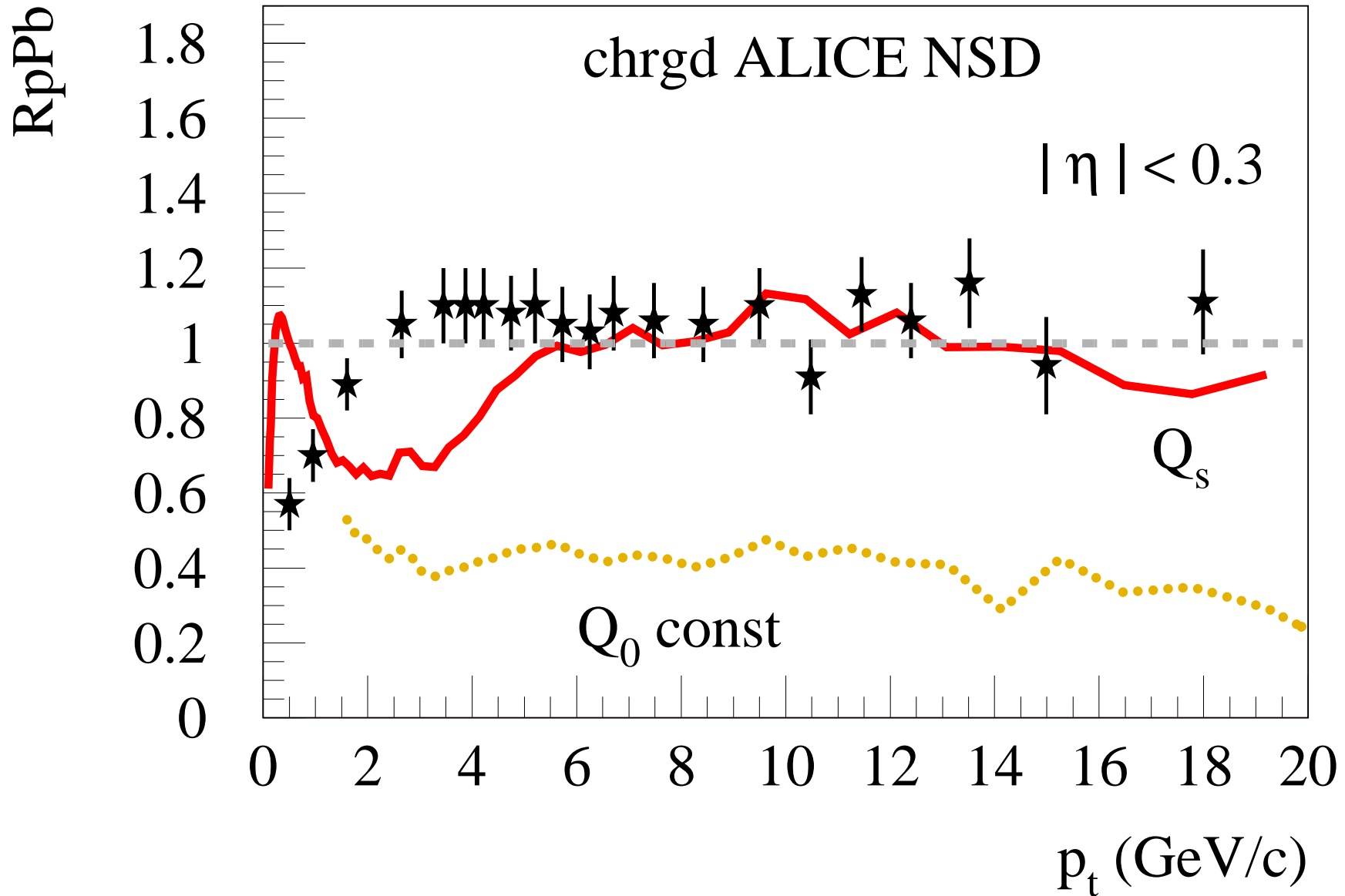

η dependence of p_t spectra in pPb

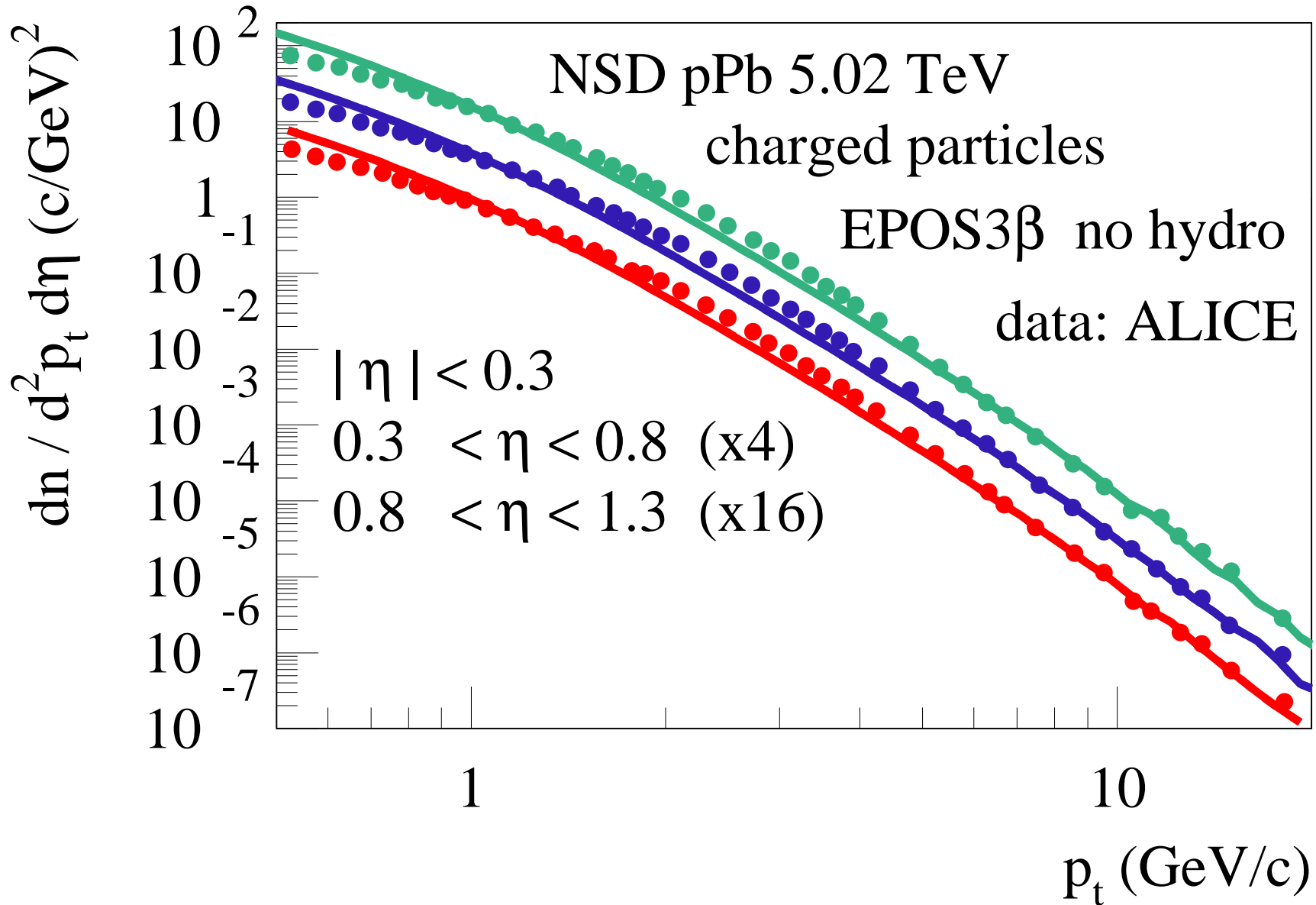

theory / data in pPb

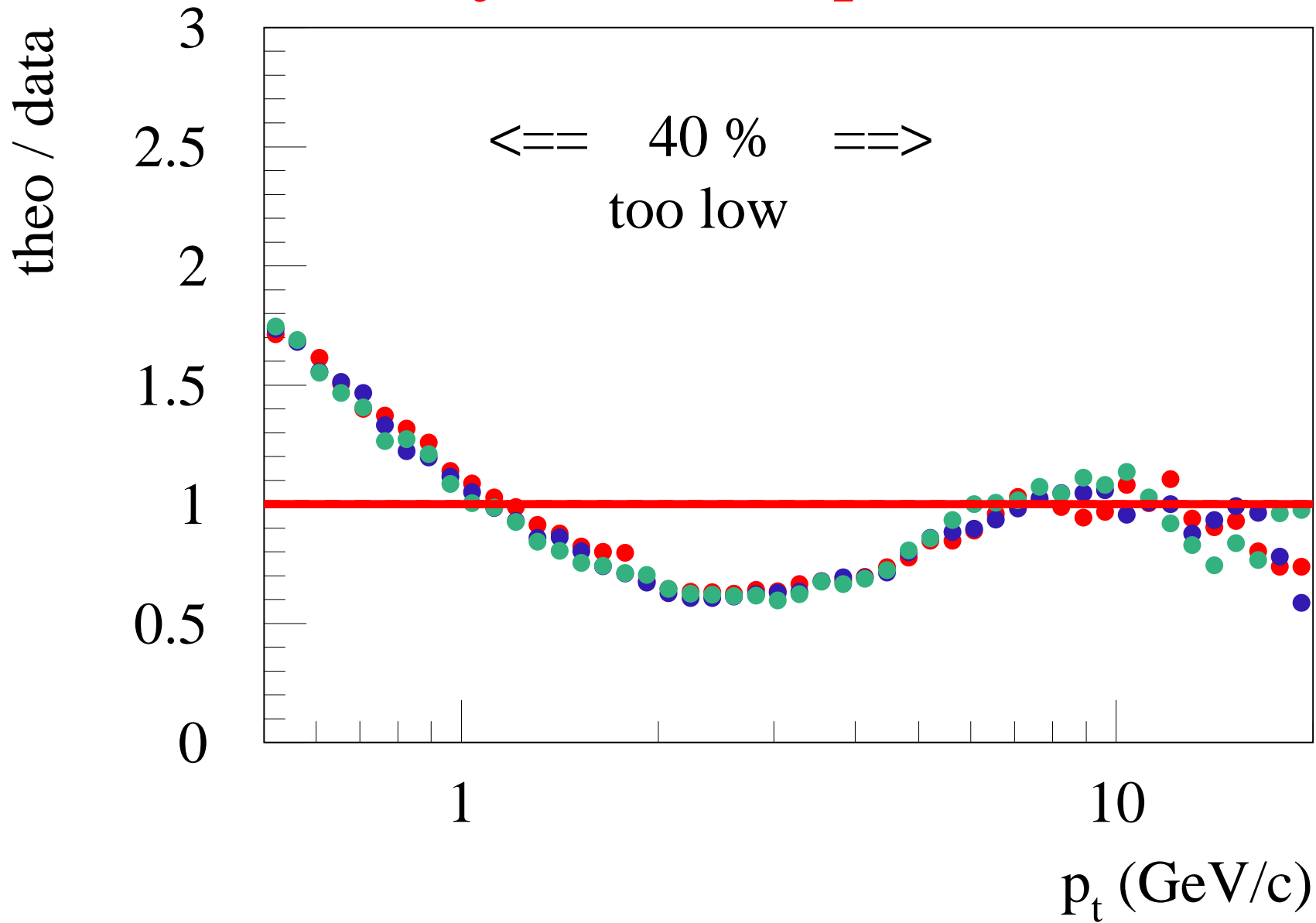

3D EbE viscous hydro

(Israel-Stewart formulation)

All calculations done with $\eta/S = 0.08$, $\zeta/S = 0$

The hydrodynamic equations in arbitrary coordinate system (implemented/solved by Yuri Karpenko)

$$\begin{aligned} \partial_{;\nu} T^{\mu\nu} &= \partial_\nu T^{\mu\nu} + \Gamma_{\nu\lambda}^\mu T^{\nu\lambda} + \Gamma_{\nu\lambda}^\nu T^{\mu\lambda} = 0 \\ \gamma (\partial_t + v_i \partial_i) \pi^{\mu\nu} &= -\frac{\pi^{\mu\nu} - \pi_{\text{NS}}^{\mu\nu}}{\tau_\pi} + I_\pi^{\mu\nu} \\ \gamma (\partial_t + v_i \partial_i) \Pi &= -\frac{\Pi - \Pi_{\text{NS}}}{\tau_\Pi} + I_\Pi \end{aligned}$$

$T^{\mu\nu} = \epsilon u^\mu u^\nu - (p + \Pi) \Delta^{\mu\nu} + \pi^{\mu\nu},$

$\partial_{;\nu}$ denotes a covariant derivative,

$\Delta^{\mu\nu} = g^{\mu\nu} - u^\mu u^\nu$ is the projector orthogonal to u^μ ,

$\pi^{\mu\nu}$ and Π are the shear stress tensor and bulk pressure, respectively.

$\pi_{\text{NS}}^{\mu\nu} = \eta(\Delta^{\mu\lambda} \partial_{;\lambda} u^\nu + \Delta^{\nu\lambda} \partial_{;\lambda} u^\mu) - \frac{2}{3} \eta \Delta^{\mu\nu} \partial_{;\lambda} u^\lambda$

$\Pi_{\text{NS}} = -\zeta \partial_{;\lambda} u^\lambda$

$I_\pi^{\mu\nu} = -\frac{4}{3} \pi^{\mu\nu} \partial_{;\gamma} u^\gamma - [u^\nu \pi^{\mu\beta} + u^\mu \pi^{\nu\beta}] u^\lambda \partial_{;\lambda} u_\beta$

$I_\Pi = -\frac{4}{3} \Pi \partial_{;\gamma} u^\gamma$

Different contributions in central pPb collisions

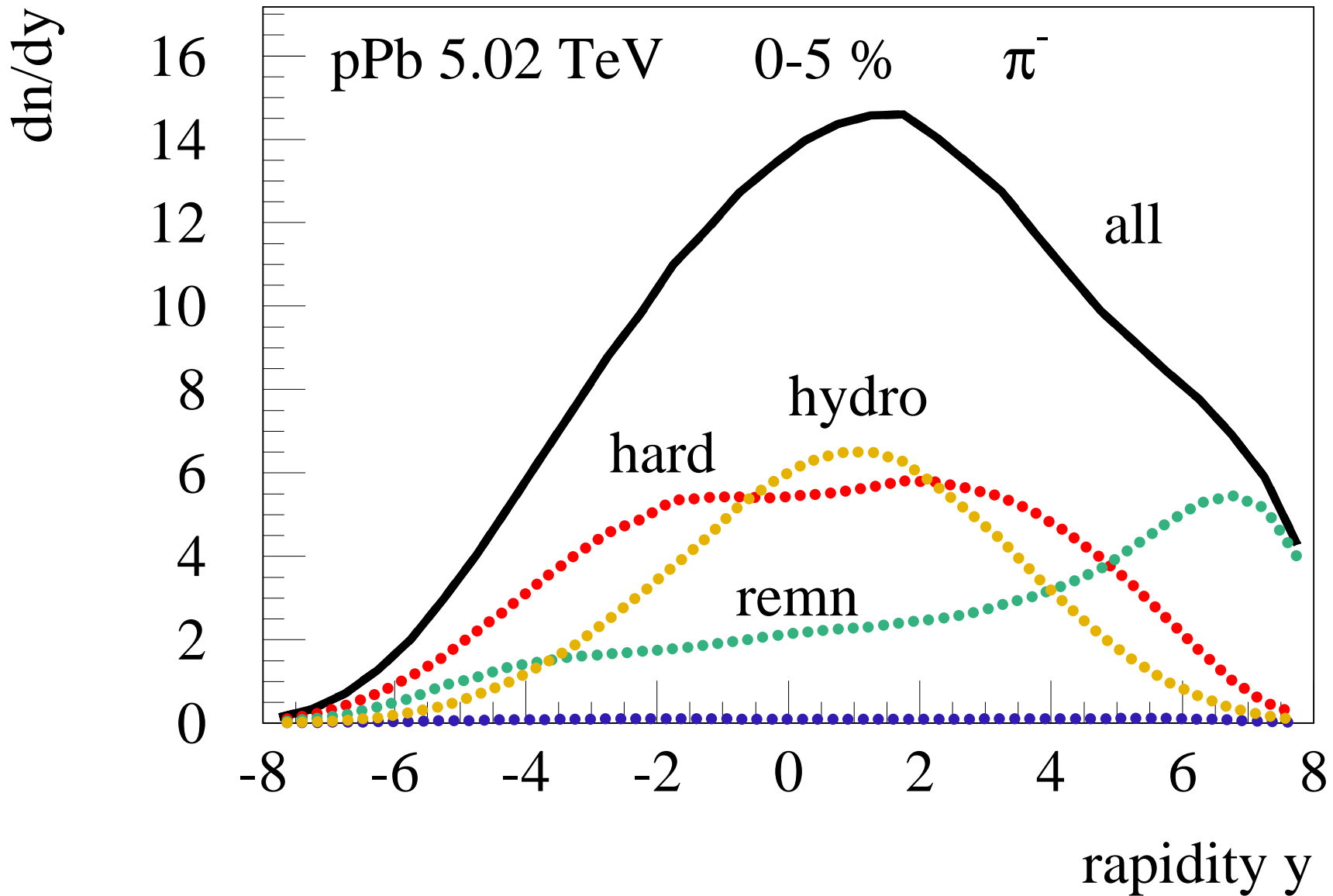

... and in peripheral pPb collisions

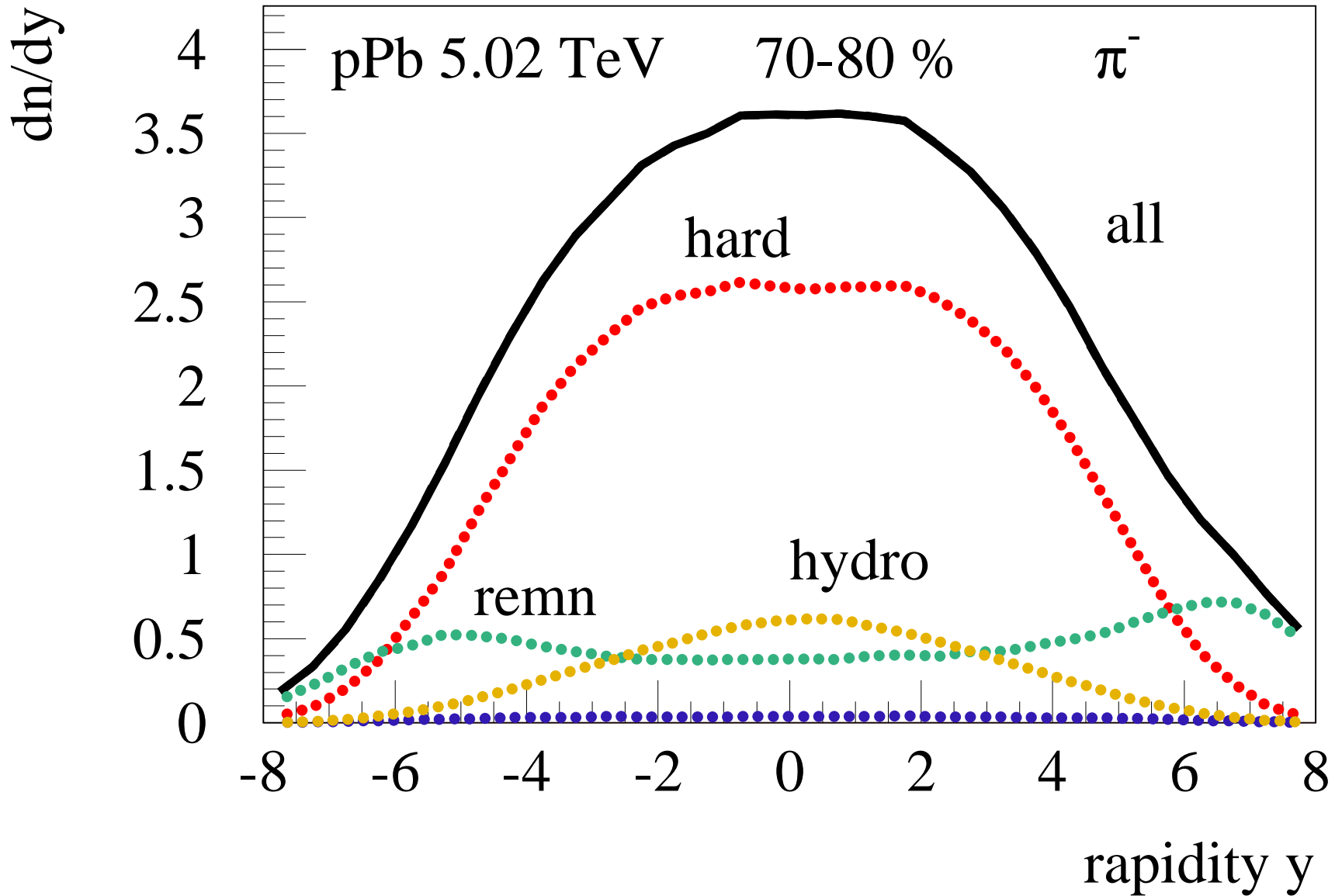

pt spectra of charged particles in NSD pPb

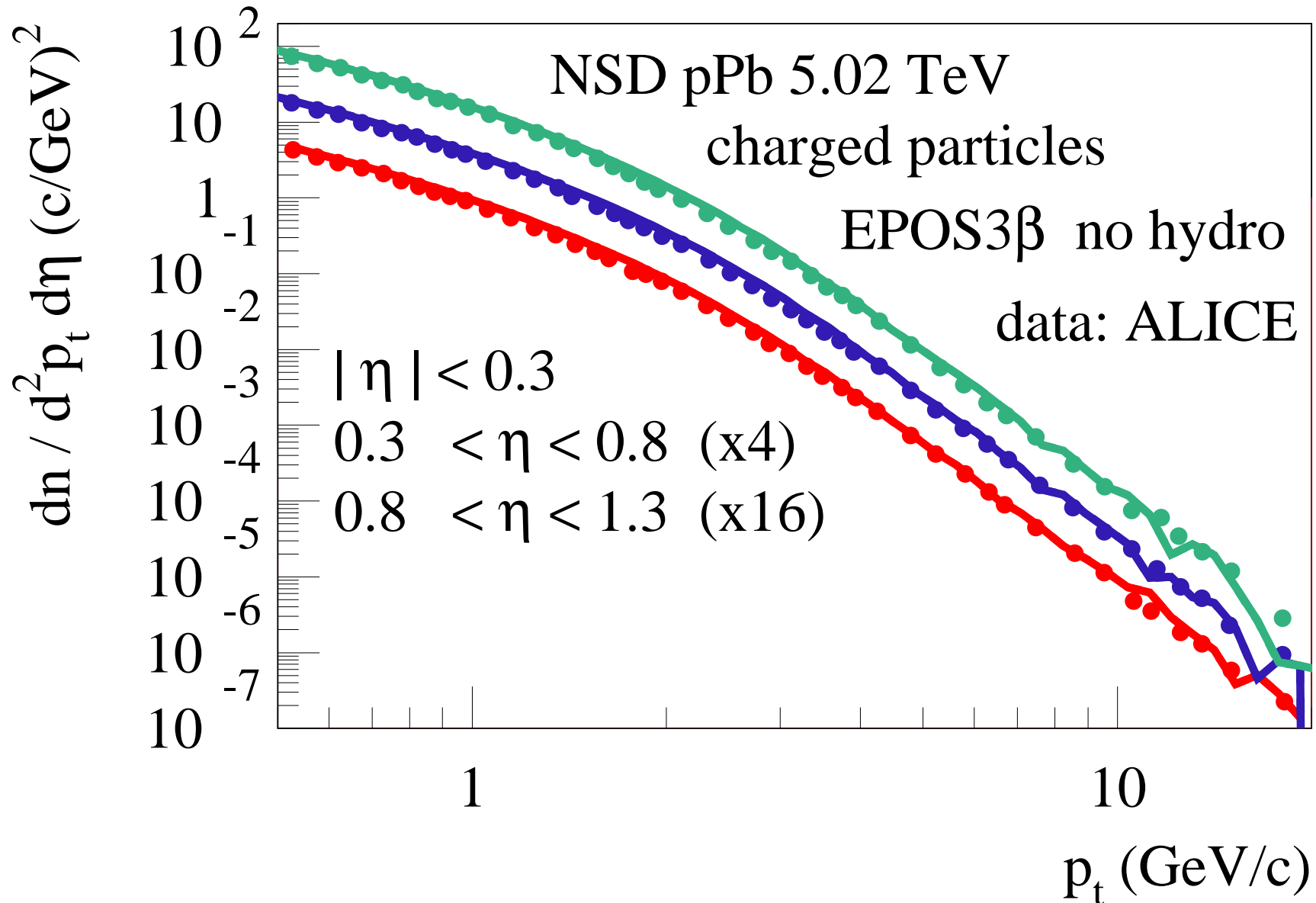

Ratio simulation / data

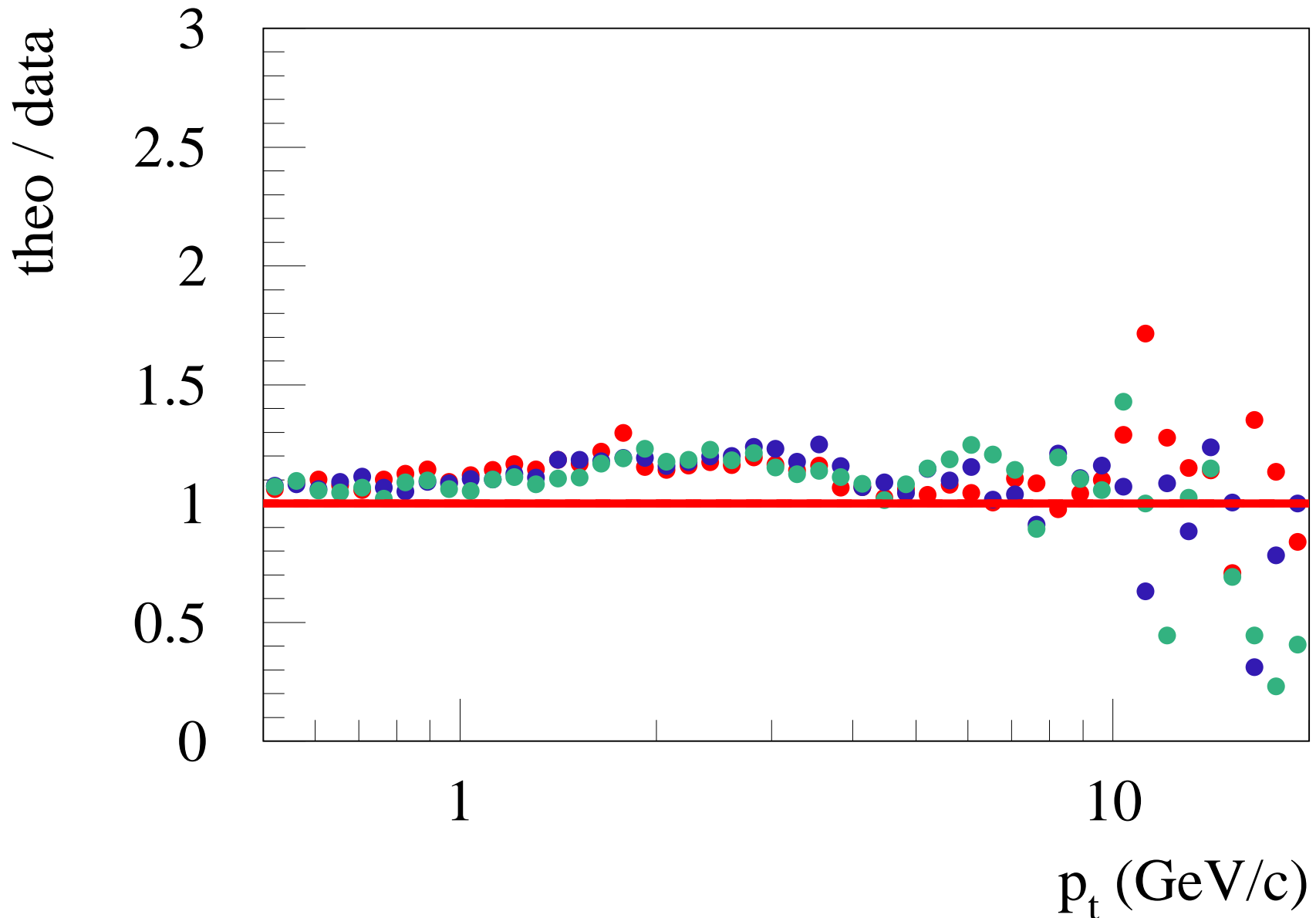

Ratio large η / small η pt distributions

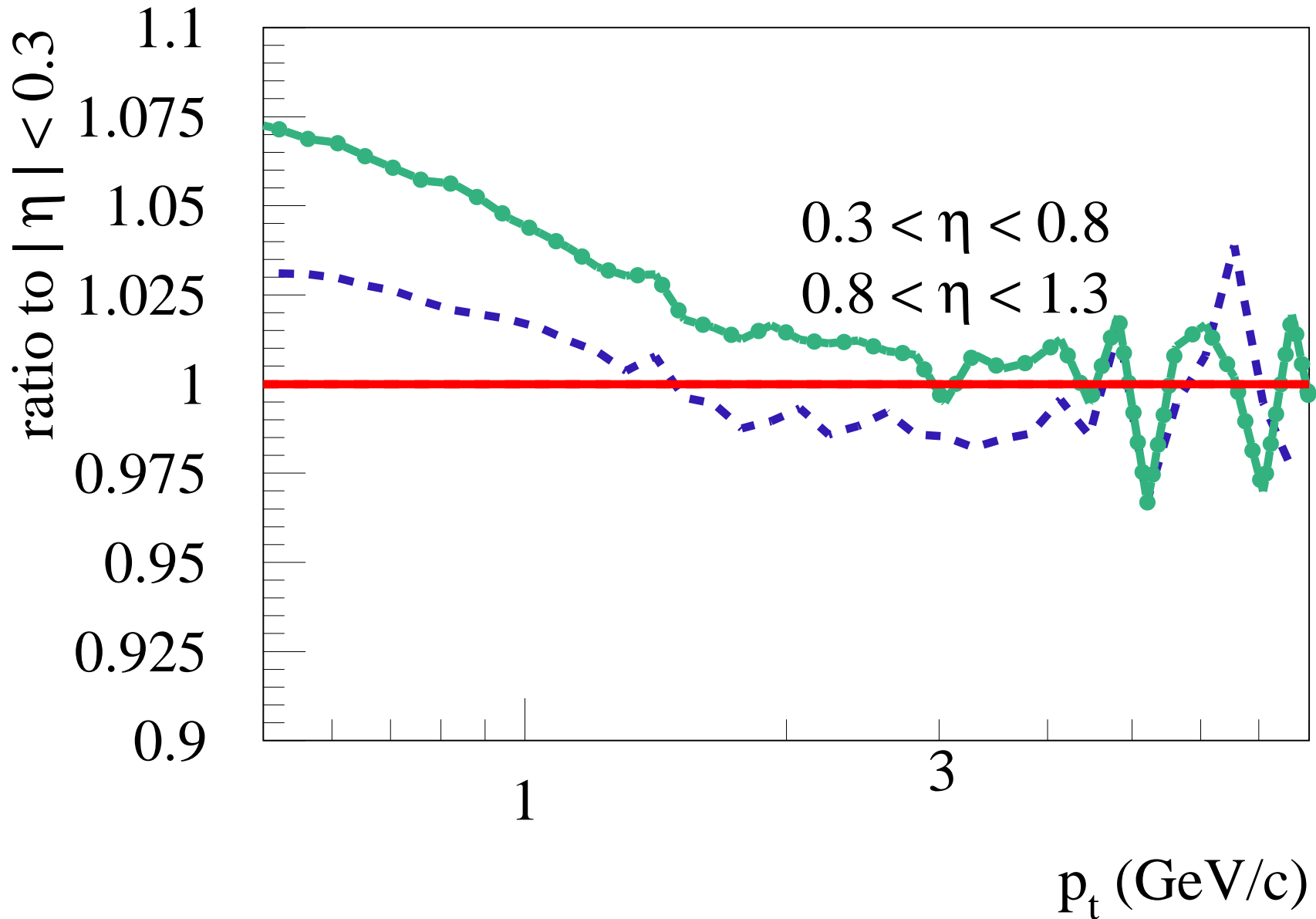

R_AA charged particles

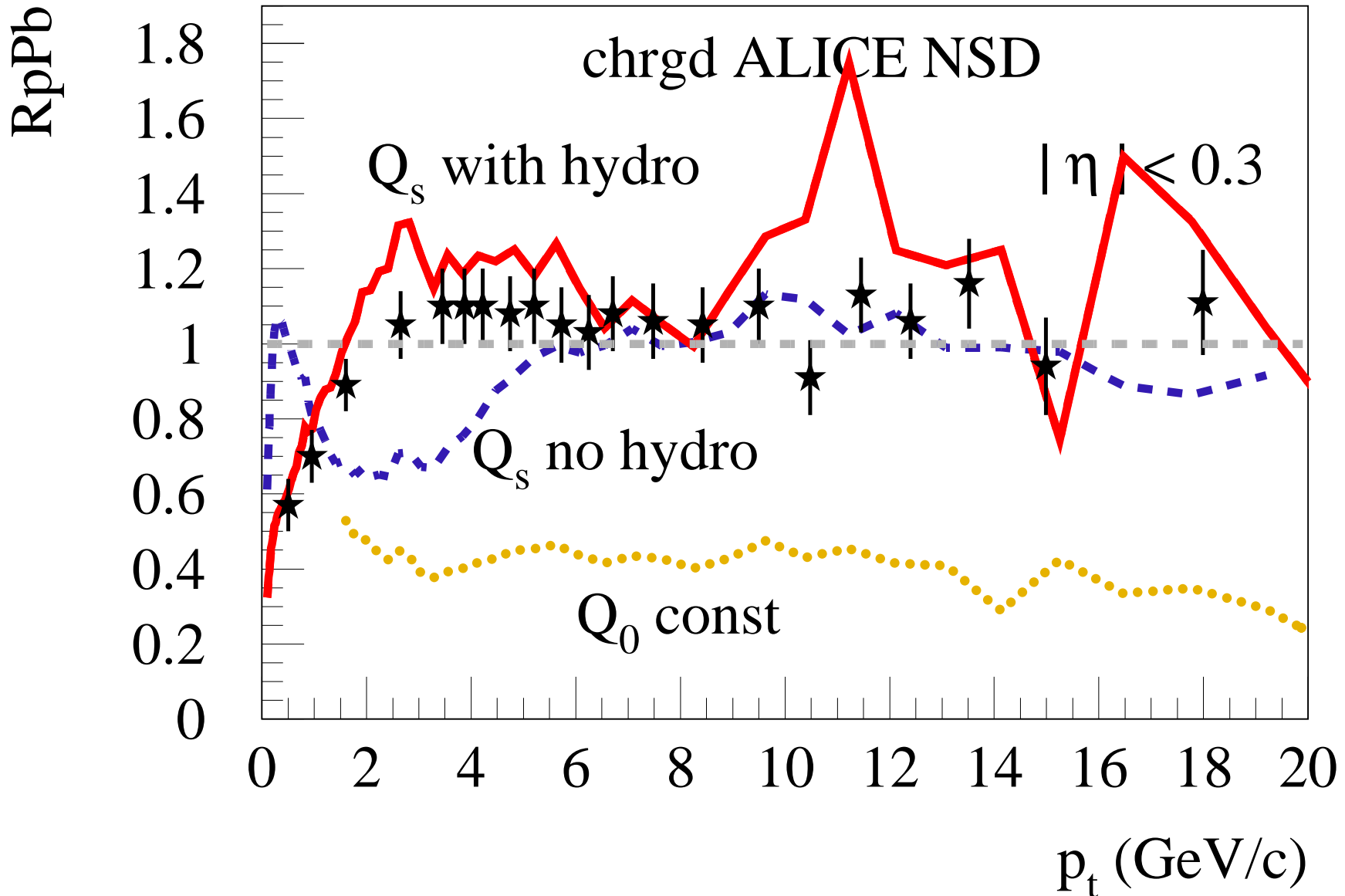

Summary

- **We (finally) get a consistent multiple scattering picture,**
 - **when energy sharing among parton ladders is accompanied by individual saturation scales $Q_s(N_{\text{part}}, s_{\text{ladd}})$**
(restores binary scaling at high p_t in pA, AA)
- **pPb: Low and intermediate p_t considerably improved by viscous hydro**
- **Crucial tests: identified particle production (p, K, lambda, xi ...), correlations**

Summary

- **We (finally) get a consistent multiple scattering picture,**
 - **when energy sharing among parton ladders is accompanied by individual saturation scales $Q_s(N_{\text{part}}, s_{\text{ladd}})$**
(restores binary scaling at high p_t in pA, AA)
- **pPb: Low and intermediate p_t considerably improved by viscous hydro**
- **Crucial tests: identified particle production (p, K, lambda, xi ...), correlations** **Thank you**